

# STANDARD MODELS

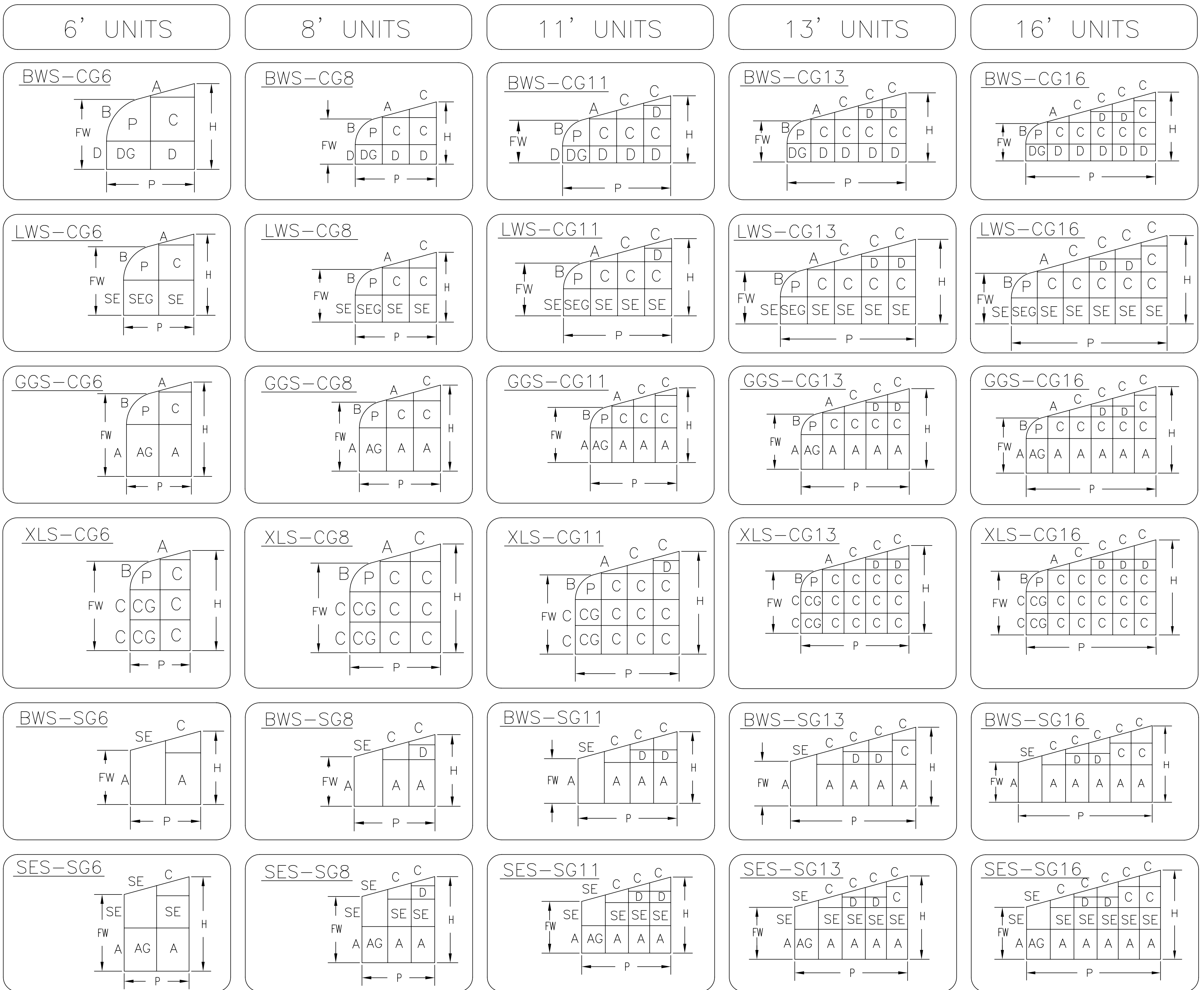

## STANDARD BACK TO BACK FREE STANDING GREENHOUSES

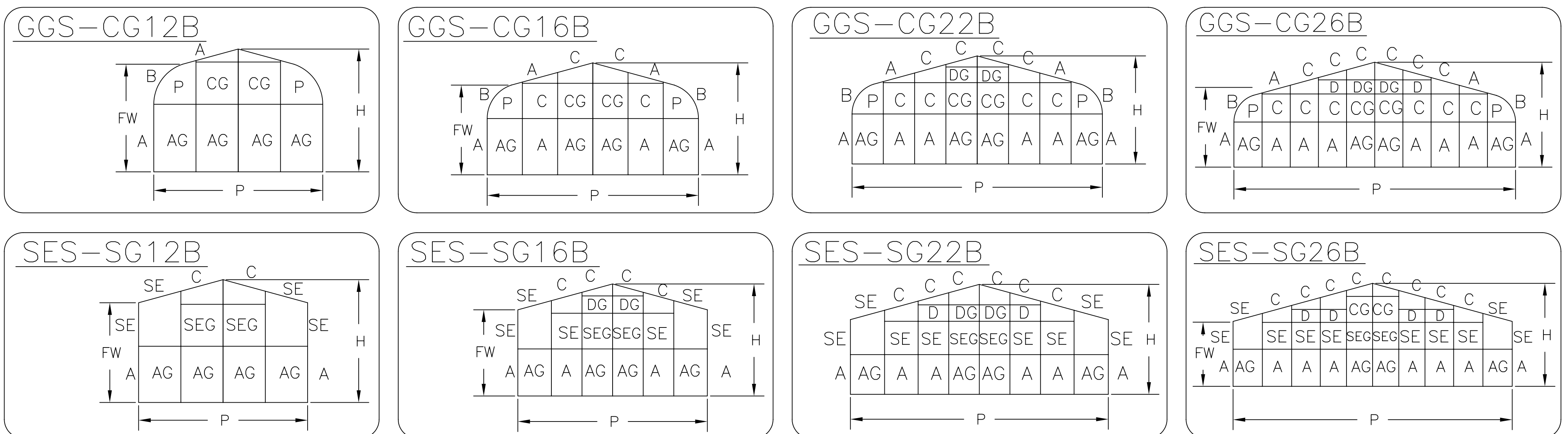

\* ALL BACK TO BACK UNITS ARE AVAILABLE IN BWS, LWS, AND XLS MODELS  
 \* WIDER STANDARD MODELS AVAILABLE. CALL FOR DETAILS.

REVISED 1/13/00

STANDARD SIZES

STANDARD MODEL DIMENSIONS

MODEL #	PROJECTION (P)	FRONT WALL HEIGHT (FW)	RIDGE HEIGHT (H)	
			SINGLE PANE	DOUBLE INS.
BWS-CG6	5'-7 3/4"	4'-0 1/4"	5'-4 7/8"	5'-5 5/8"
LWS-CG6	5'-7 3/4"	5'-9 3/4"	7'-2 3/8"	7'-3 1/8"
GGG-CG6	5'-7 3/4"	6'-7 1/2"	8'-0 1/8"	8'-0 7/8"
XLS-CG6	5'-7 3/4"	8'-1"	9'-5 5/8"	9'-6 3/8"
BWS-SG6	5'-7 3/4"	4'-0"	5'-10 3/8"	5'-11 1/8"
SES-SG6	5'-7 3/4"	7'-1 1/4"	8'-11 5/8"	9'-0 3/8"
BWS-CG8	8'-2 5/8"	4'-0 1/4"	6'-2 1/8"	6'-3"
LWS-CG8	8'-2 5/8"	5'-9 3/4"	7'-11 5/8"	8'-0 1/2"
GGG-CG8	8'-2 5/8"	6'-7 1/2"	8'-9 3/8"	8'-10 1/4"
XLS-CG8	8'-2 5/8"	8'-1"	10'-2 7/8"	10'-3 3/4"
BWS-SG8	8'-2 5/8"	4'-0"	6'-7 3/4"	6'-8 1/2"
SES-SG8	8'-2 5/8"	7'-1 1/4"	9'-9"	9'-9 3/4"
BWS-CG11	10'-9 1/2"	4'-0 1/4"	6'-11 1/2"	7'-0 1/4"
LWS-CG11	10'-9 1/2"	5'-9 3/4"	8'-9"	8'-9 3/4"
GGG-CG11	10'-9 1/2"	6'-7 1/2"	9'-6 3/4"	9'-7 1/2"
XLS-CG11	10'-9 1/2"	8'-1"	11'-0 1/4"	11'-1"
BWS-SG11	10'-9 1/2"	4'-0"	7'-5"	7'-5 3/4"
SES-SG11	10'-9 1/2"	7'-1 1/4"	10'-6 1/4"	10'-7"
BWS-CG13	13'-4 3/8"	4'-0 1/4"	7'-8 3/4"	7'-9 5/8"
LWS-CG13	13'-4 3/8"	5'-9 3/4"	9'-6 1/4"	9'-7 1/8"
GGG-CG13	13'-4 3/8"	6'-7 1/2"	10'-4"	10'-4 7/8"
XLS-CG13	13'-4 3/8"	8'-1"	11'-9 1/2"	11'-10 3/8"
BWS-SG13	13'-4 3/8"	4'-0"	8'-2 3/8"	8'-3 1/8"
SES-SG13	13'-4 3/8"	7'-1 1/4"	11'-3 5/8"	11'-4 3/8"
BWS-CG16	15'-11 1/4"	4'-0 1/4"	8'-6 1/8"	8'-6 7/8"
LWS-CG16	15'-11 1/4"	5'-9 3/4"	10'-3 5/8"	10'-4 3/8"
GGG-CG16	15'-11 1/4"	6'-7 1/2"	11'-1 3/8"	11'-2 1/8"
XLS-CG16	15'-11 1/4"	8'-1"	12'-6 7/8"	12'-7 5/8"
BWS-SG16	15'-11 1/4"	4'-0"	8'-11 5/8"	9'-0 3/8"
SES-SG16	15'-11 1/4"	7'-1 1/4"	12'-0 7/8"	12'-1 5/8"
GGG-CG12B	11'-3 1/2"	6'-7 1/2"	8'-0 1/8"	8'-0 7/8"
GGG-CG16B	16'-5 1/4"	6'-7 1/2"	8'-9 3/8"	8'-10 1/4"
GGG-CG22B	21'-7"	6'-7 1/2"	9'-6 3/4"	9'-7 1/2"
GGG-CG26B	26'-8 3/4"	6'-7 1/2"	10'-4"	10'-4 7/8"
SES-SG12B	11'-3 1/2"	7'-1 1/4"	8'-11 5/8"	9'-0 3/8"
SES-SG16B	16'-5 1/4"	7'-1 1/4"	9'-9"	9'-9 3/4"
SES-SG22B	21'-7"	7'-1 1/4"	10'-6 1/4"	10'-7"
SES-SG26B	26'-8 3/4"	7'-1 1/4"	11'-3 5/8"	11'-4 3/8"

\*NOTE\* ALL DIMENSIONS ARE OUT TO OUT OF METAL

STANDARD BASE LENGTHS

NUMBER OF PANELS	BASE LENGTH
1	2'-9 3/8"
2	5'-4 1/4"
3	7'-11 1/8"
4	10'-6"
5	13'-0 7/8"
6	15'-7 3/4"
7	18'-2 5/8"
8	20'-9 1/2"
9	23'-4 3/8"
10	25'-11 1/4"
11	28'-6 1/8"
12	31'-1"
13	33'-7 7/8"
14	36'-2 3/4"
15	38'-9 5/8"
16	41'-4 1/2"
17	43'-11 3/8"
18	46'-6 1/4"
19	49'-1 1/8"
20	51'-8"
21	54'-2 7/8"
22	56'-9 3/4"
23	59'-4 5/8"
24	61'-11 1/2"
25	64'-6 3/8"
ADD-ON PER PANEL	2'-6 7/8"

# STANDARD LOW PITCH MODELS – GENEVA

6' UNITS

8' UNITS

11' UNITS

13' UNITS

16' UNITS

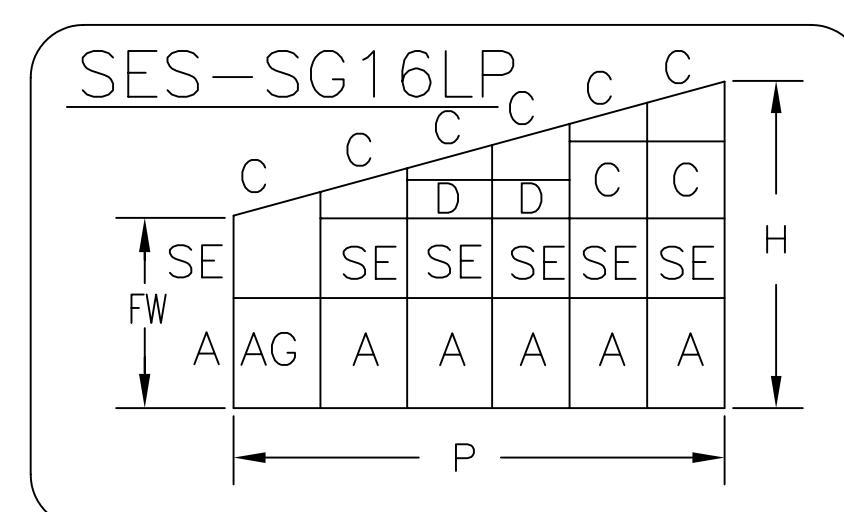
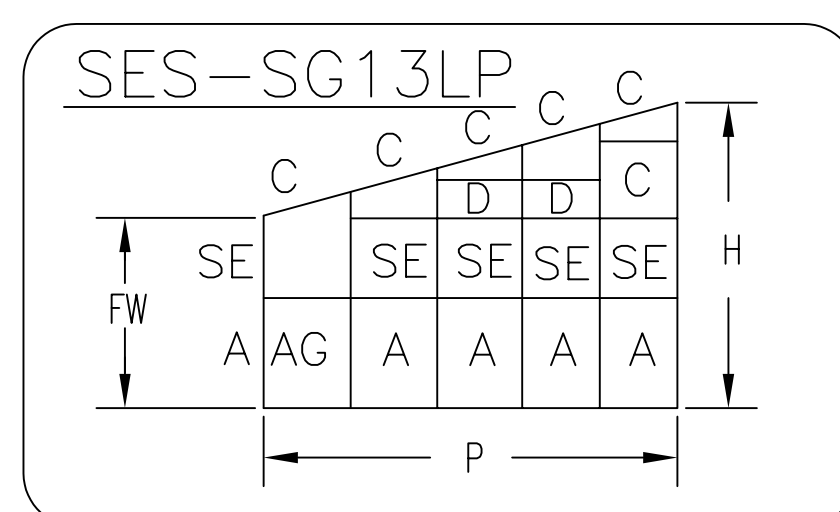
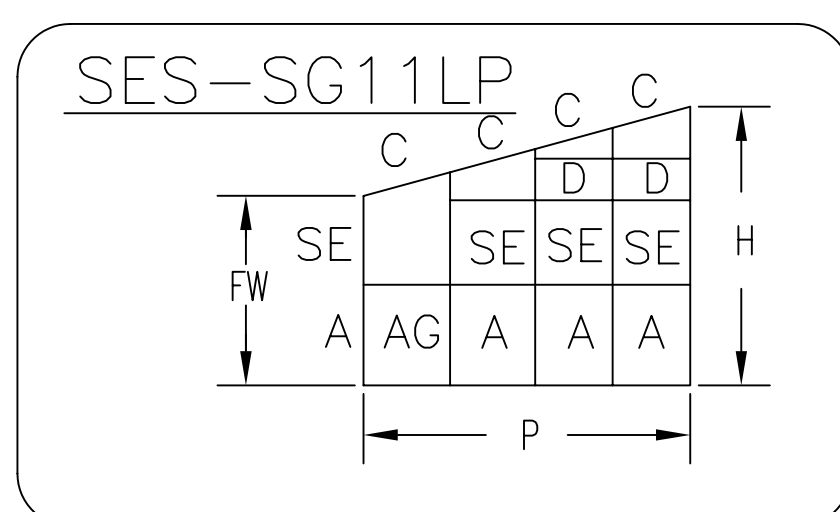
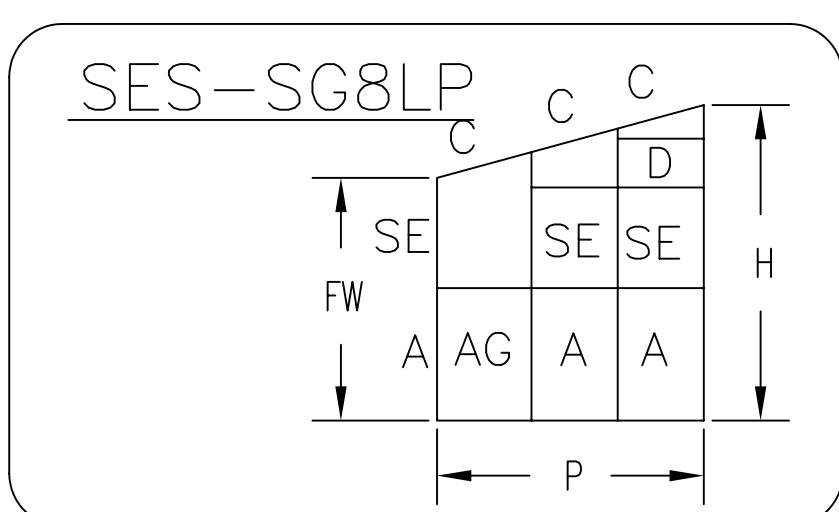
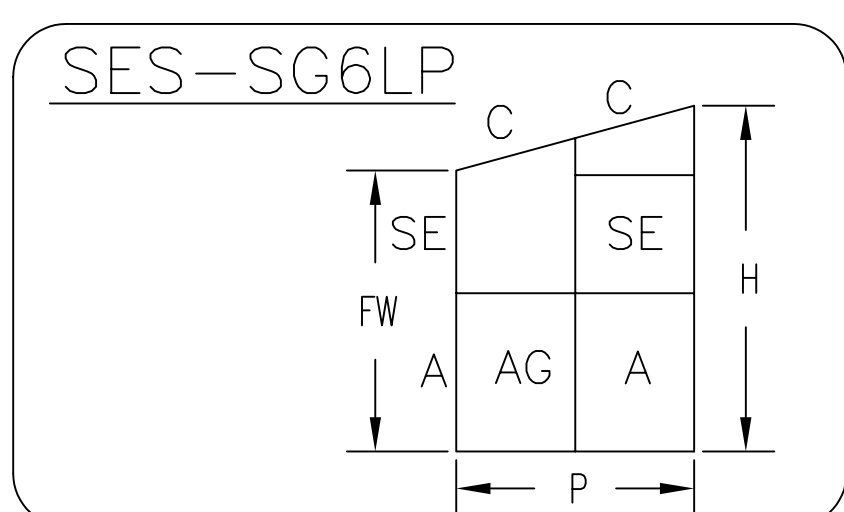
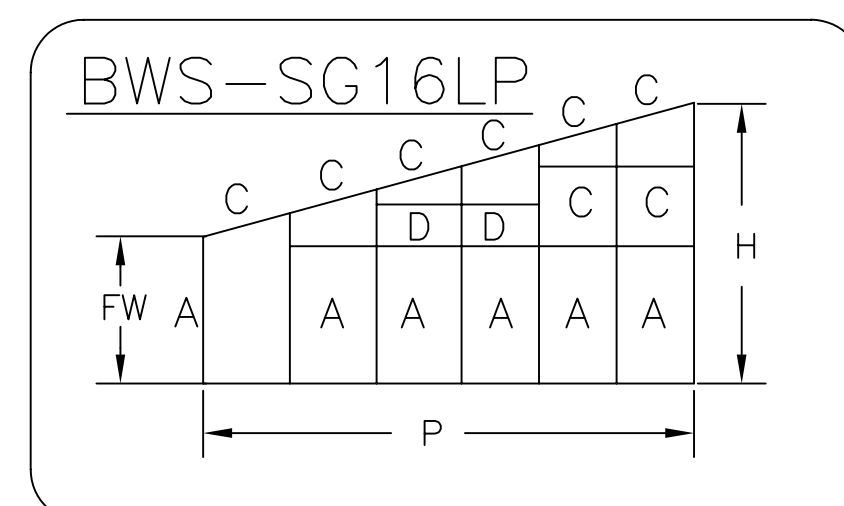
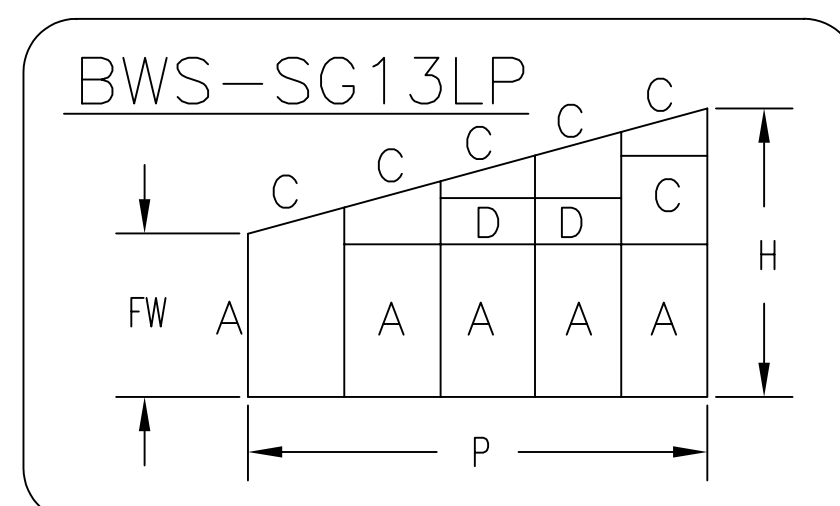
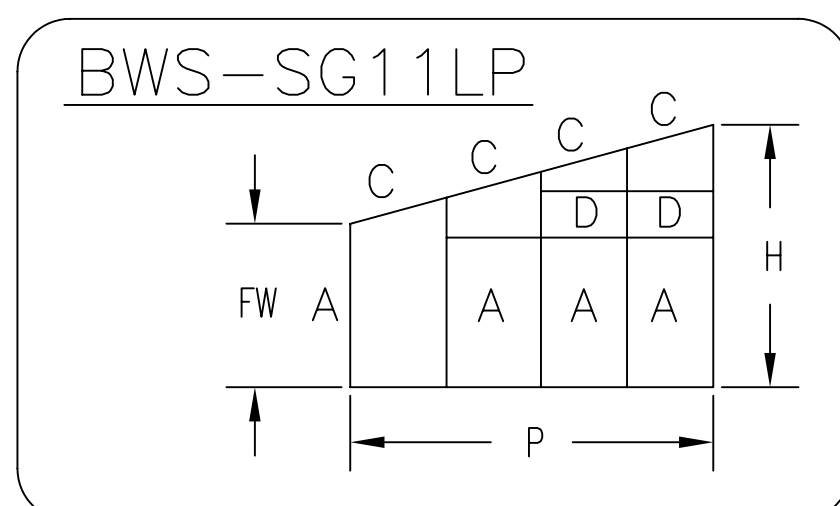
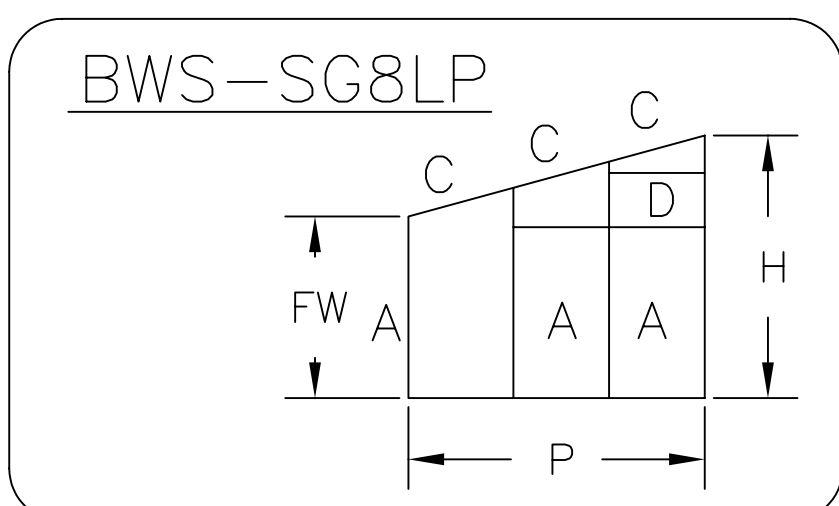
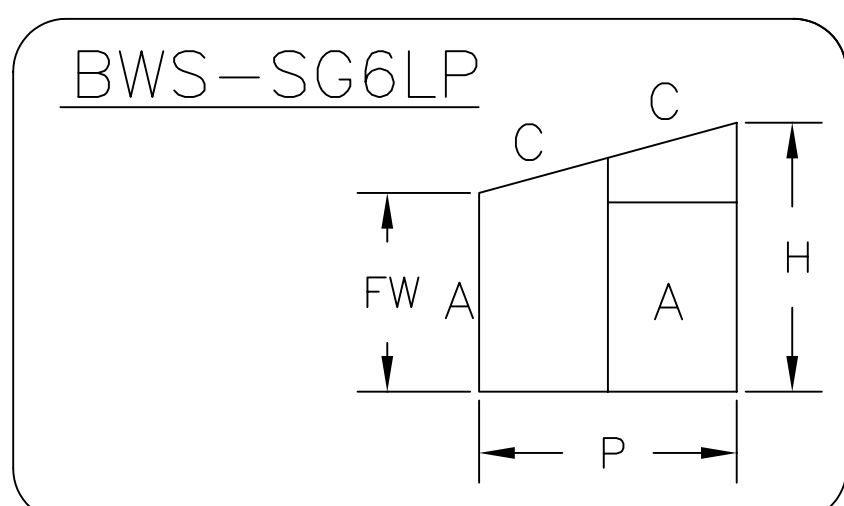
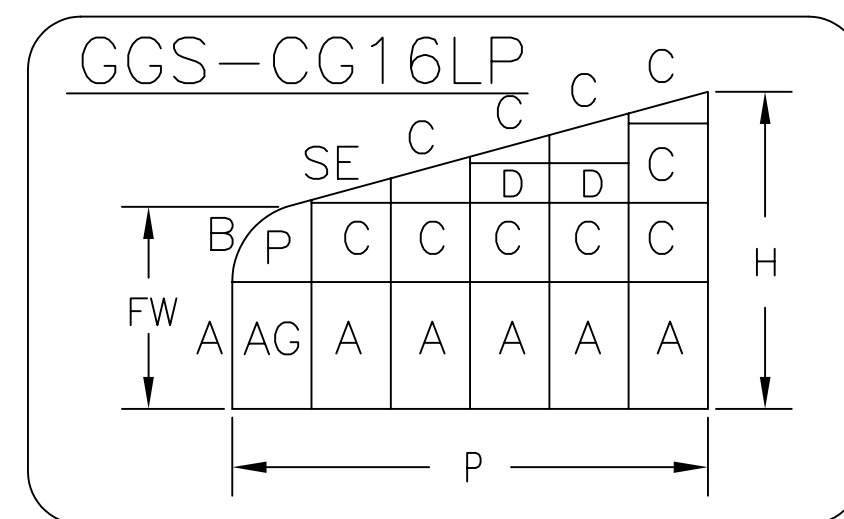
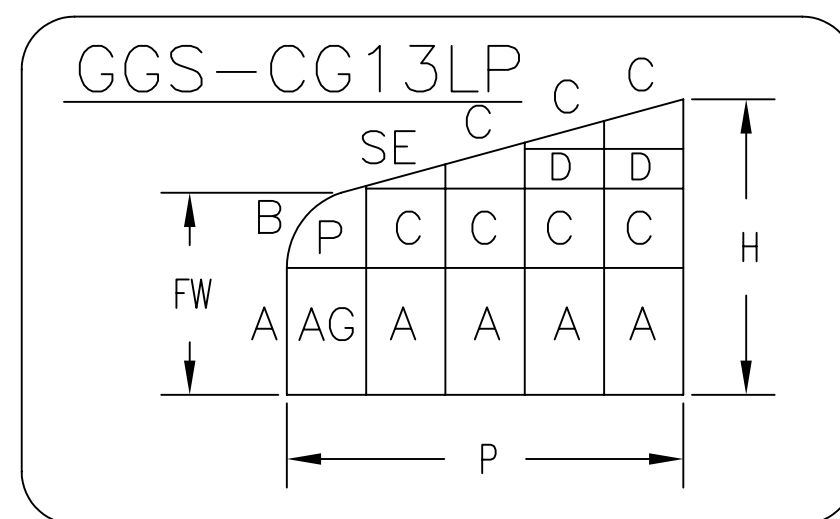
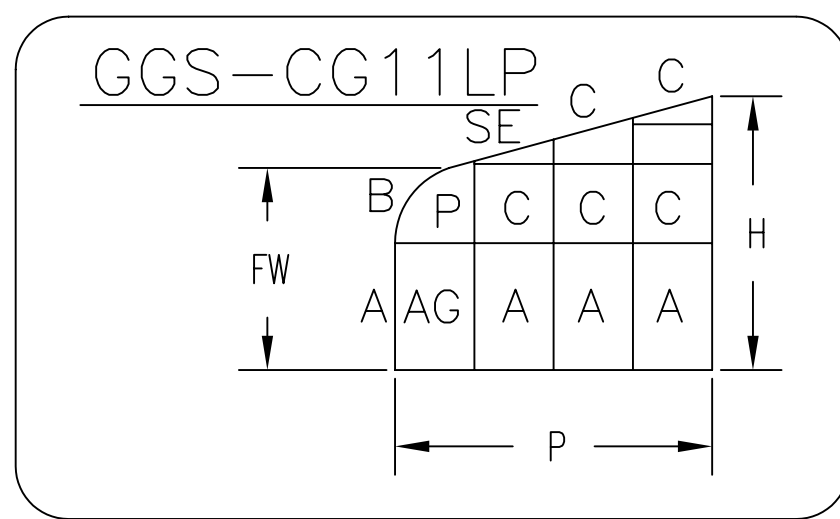
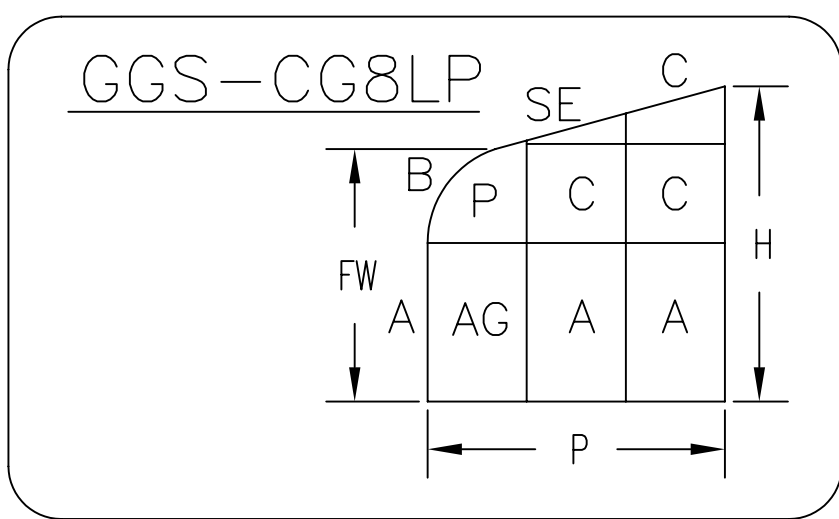
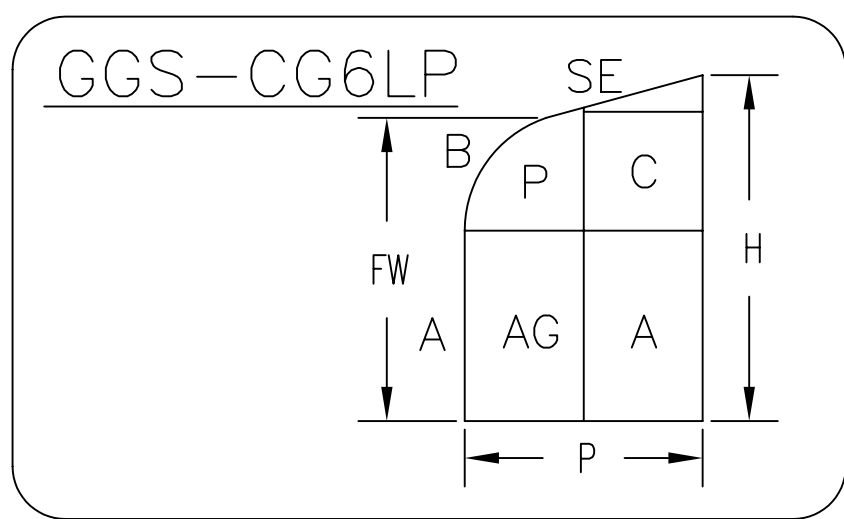
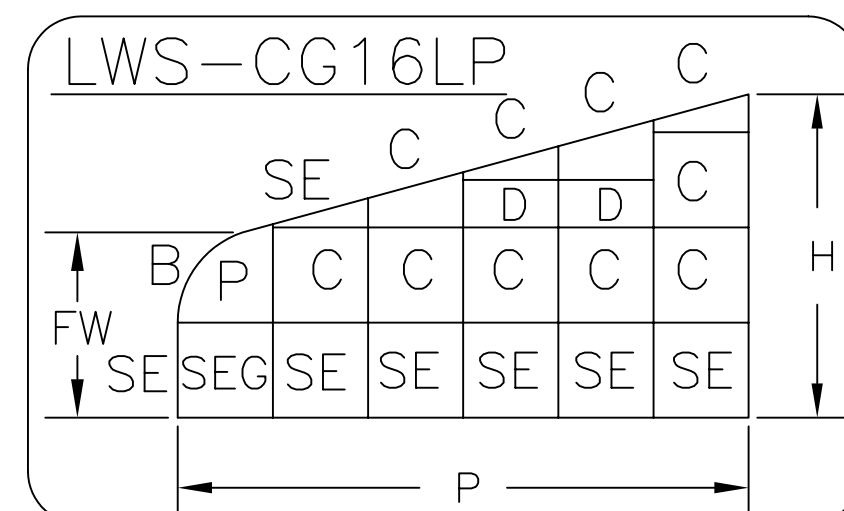
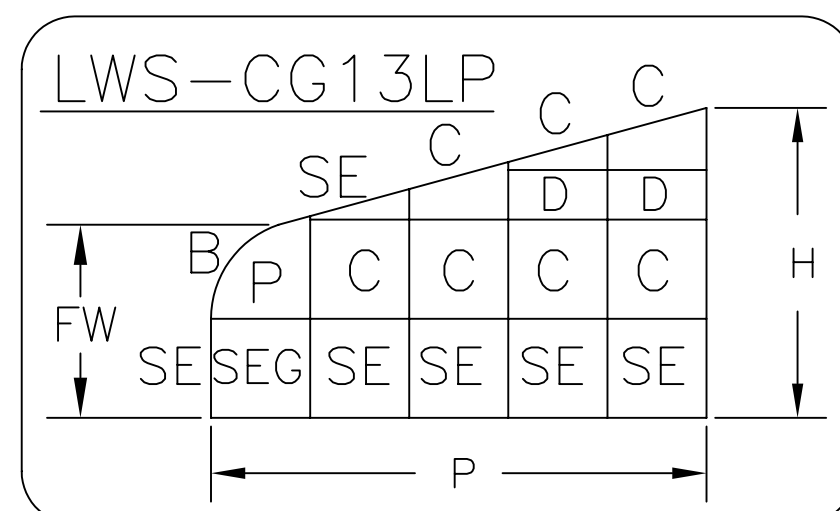
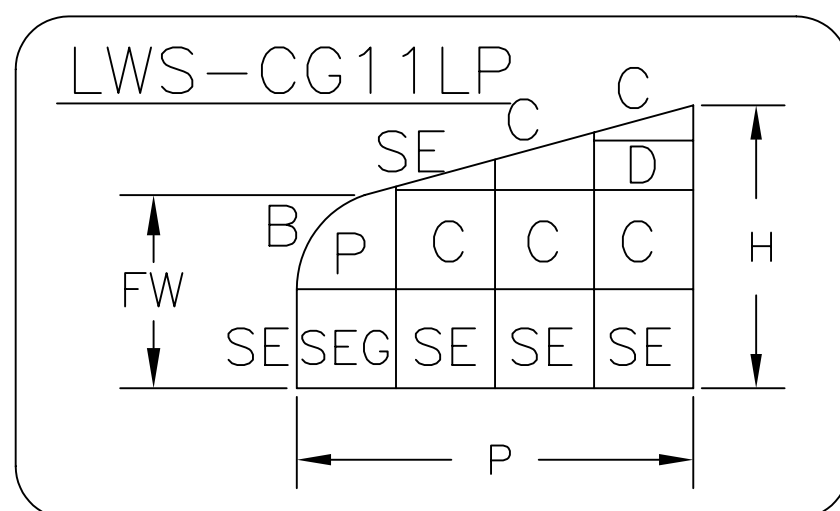
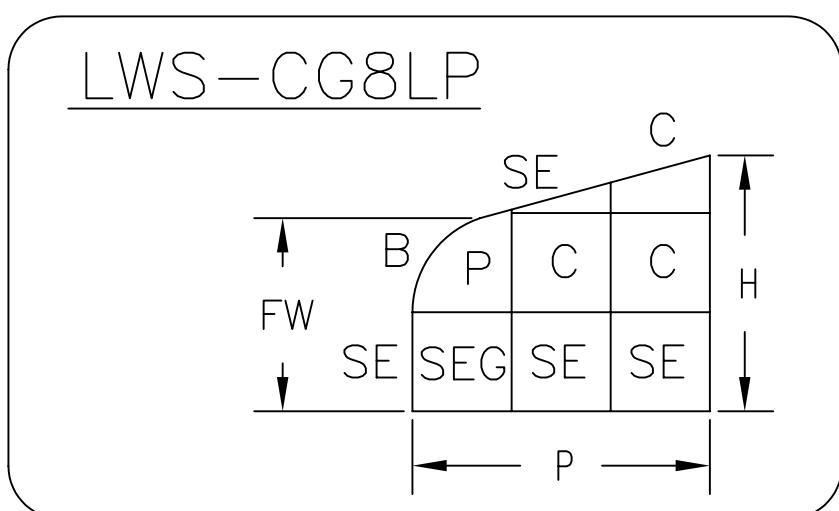
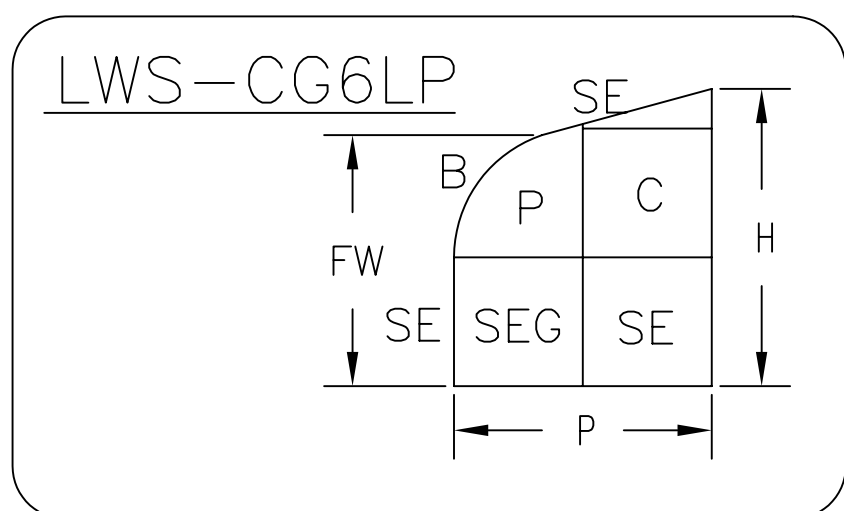
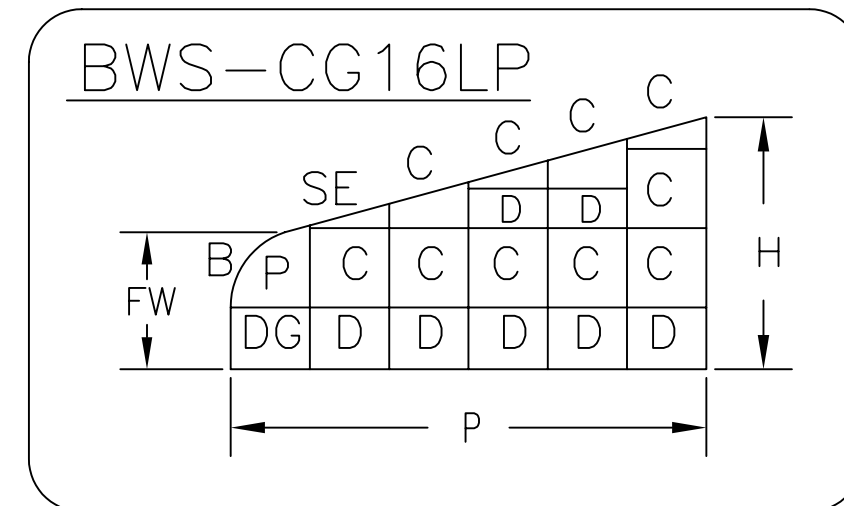
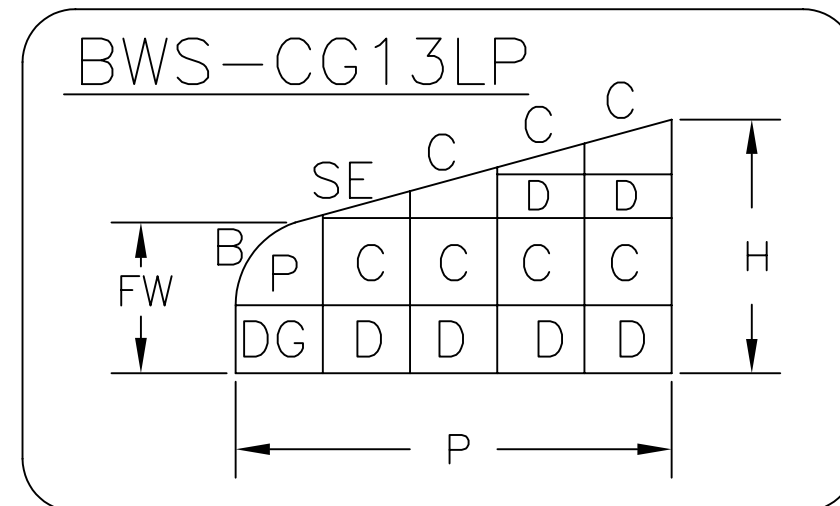
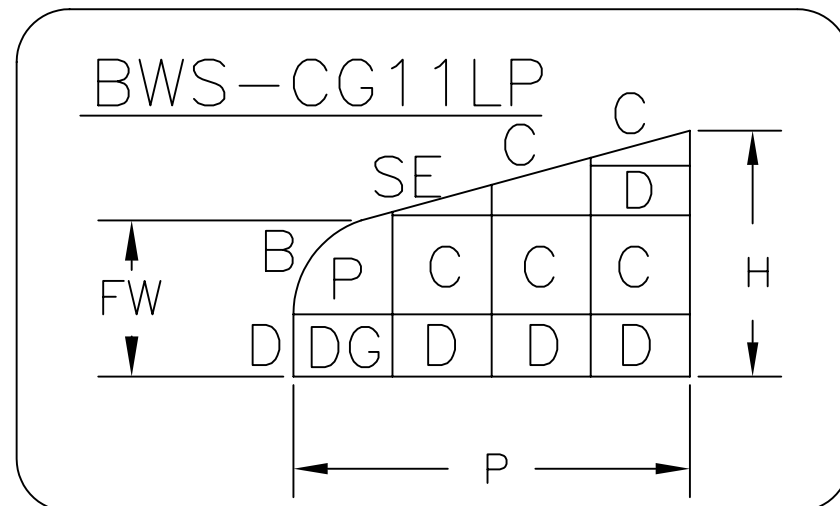
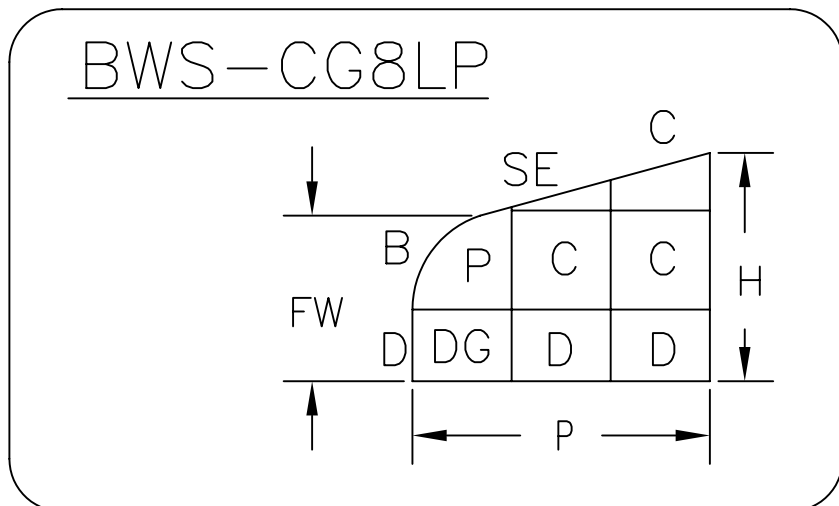
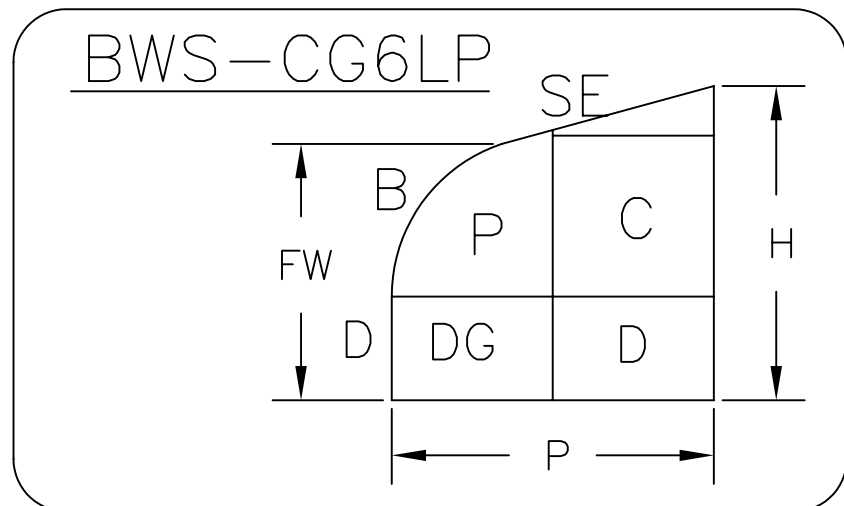

# STANDARD LOW PITCH SIZES – GENEVA

## STANDARD LOW-PITCH MODEL DIMENSIONS

MODEL #	PROJECTION (P)	FRONT WALL HEIGHT (FW)	RIDGE HEIGHT (H)	
			SINGLE PANE	DOUBLE INS.
BWS-CG6LP	5'-3 7/8"	4'-0 1/4"	5'-3 1/8"	5'-3 7/8"
LWS-CG6LP	5'-3 7/8"	5'-9 3/4"	6'-4 1/2"	6'-5 1/4"
GGG-CG6LP	5'-3 7/8"	6'-7 1/2"	7'-2 1/4"	7'-3"
BWS-SG6LP	5'-4 7/8"	4'-0"	5'-1 1/4"	5'-2"
SES-SG6LP	5'-4 7/8"	7'-1 1/4"	8'-2 1/2"	8'-3 1/4"
BWS-CG8LP	7'-11 5/8"	4'-0 1/4"	5'-0 1/2"	5'-1 1/4"
LWS-CG8LP	7'-11 5/8"	5'-9 3/4"	6'-10"	6'-10 3/4"
GGG-CG8LP	7'-11 5/8"	6'-7 1/2"	7'-7 3/4"	7'-8 1/2"
BWS-SG8LP	8'-0 3/4"	4'-0"	5'-6 7/8"	5'-7 5/8"
SES-SG8LP	8'-0 3/4"	7'-1 1/4"	8'-8 1/8"	8'-8 7/8"
BWS-CG11LP	10'-7 3/8"	4'-0 1/4"	5'-6"	5'-6 3/4"
LWS-CG11LP	10'-7 3/8"	5'-9 3/4"	7'-3 1/2"	7'-4 1/4"
GGG-CG11LP	10'-7 3/8"	6'-7 1/2"	8'-1 1/4"	8'-2"
BWS-SG11LP	10'-8 1/2"	4'-0"	6'-0 3/8"	6'-1 1/8"
SES-SG11LP	10'-8 1/2"	7'-1 1/4"	9'-1 5/8"	9'-2 3/8"
BWS-CG13LP	13'-3 1/8"	4'-0 1/4"	5'-11 1/2"	6'-0 1/4"
LWS-CG13LP	13'-3 1/8"	5'-9 3/4"	7'-9"	7'-9 3/4"
GGG-CG13LP	13'-3 1/8"	6'-7 1/2"	8'-6 3/4"	8'-7 1/2"
BWS-SG13LP	13'-4 1/4"	4'-0"	6'-5 7/8"	6'-6 5/8"
SES-SG13LP	13'-4 1/4"	7'-1 1/4"	9'-7 1/8"	9'-7 7/8"
BWS-CG16LP	15'-10 7/8"	4'-0 1/4"	6'-5"	6'-5 3/4"
LWS-CG16LP	15'-10 7/8"	5'-9 3/4"	8'-2 1/2"	8'-3 1/4"
GGG-CG16LP	15'-10 7/8"	6'-7 1/2"	9'-0 1/4"	9'-1"
BWS-SG16LP	16'-0"	4'-0"	6'-11 3/8"	7'-0 1/8"
SES-SG16LP	16'-0"	7'-1 1/4"	10'-0 5/8"	10'-1 3/8"

\*NOTE\* ALL DIMENSIONS ARE  
OUT TO OUT OF METAL

## STANDARD BASE LENGTHS

NUMBER OF PANELS	BASE LENGTH
1	2'-9 3/8"
2	5'-4 1/4"
3	7'-11 1/8"
4	10'-6"
5	13'-0 7/8"
6	15'-7 3/4"
7	18'-2 5/8"
8	20'-9 1/2"
9	23'-4 3/8"
10	25'-11 1/4"
11	28'-6 1/8"
12	31'-1"
13	33'-7 7/8"
14	36'-2 3/4"
15	38'-9 5/8"
16	41'-4 1/2"
17	43'-11 3/8"
18	46'-6 1/4"
19	49'-1 1/8"
20	51'-8"
21	54'-2 7/8"
22	56'-9 3/4"
23	59'-4 5/8"
24	61'-11 1/2"
25	64'-6 3/8"
ADD-ON PER PANEL	2'-6 7/8"